





74.243_00



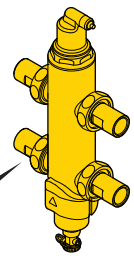

 0 ... bar

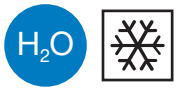
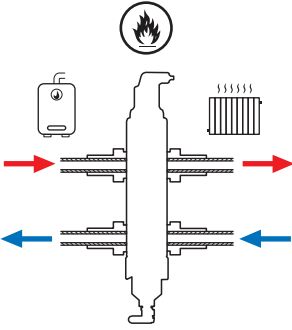
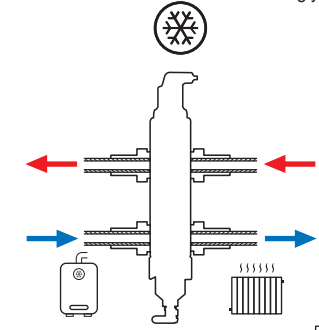

 0 ... °C

Acc.PED (2014/68/EU §4.3)

1

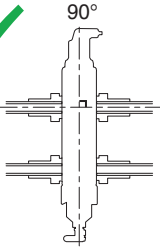

2

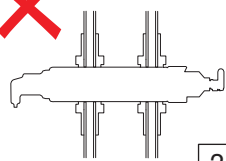
3



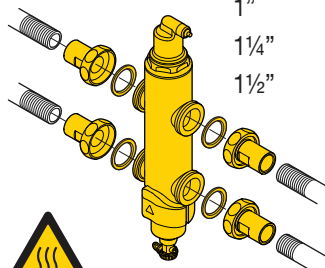

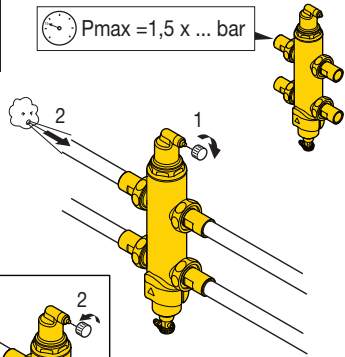
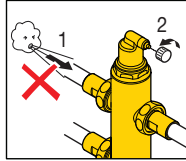

1"
1 1/4"
1 1/2"

 0 bar

4

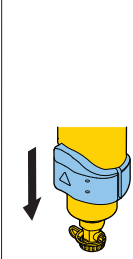
 Pmax = 1,5 x ... bar
 

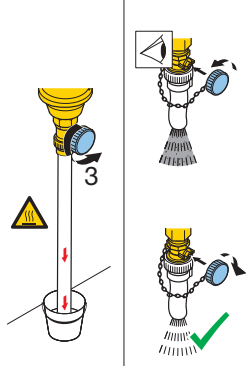
5

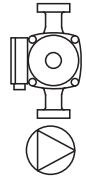
6